

Cooper & Co.

Boston

Bookcase

ASSEMBLY
INSTRUCTIONS

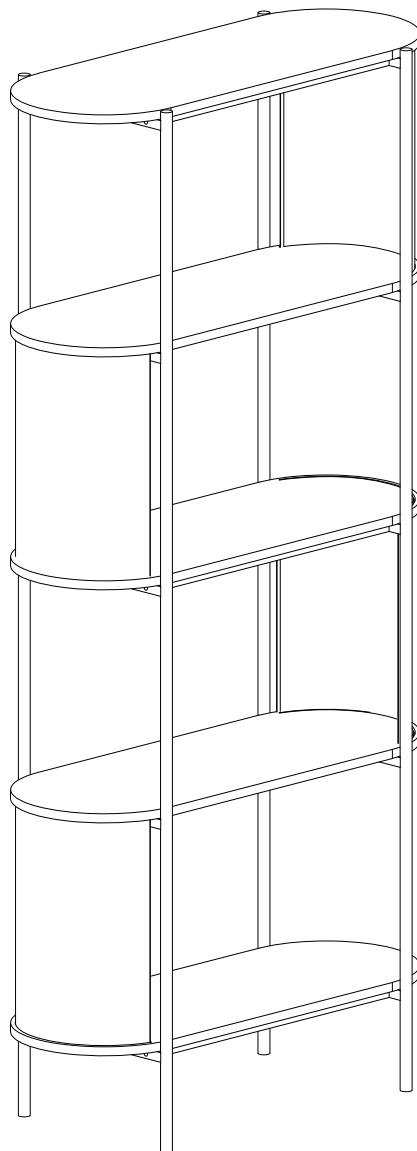

Cheers for making this yours!

Cooper & Co is your go-to source for homeware that's as stylish as it is affordable! With our carefully curated selection, we aim to bring you the best of both worlds, ensuring that you can create a space that reflects your personal style without breaking the bank.

We're on a mission to sprinkle some pizzazz into every home. Whether you're looking to transform your living room, kitchen, or bedroom into a masterpiece, fret not! With us, you don't have to sacrifice quality or design.

TIPS BEFORE YOU START



1. Sit back, take a deep breath, and get ready to dive into the laid-back world of furniture assembly. We've got your back with some simple instructions that will have you relaxing with your amazing new piece in no time.
2. Please check that all parts are present before you start the assembly of your furniture.
3. For ease and speed of assembly, we recommend that before you commence each step of the assembly, that you identify all the parts required for that step.
4. For larger items, please ensure that you have sufficient space and people to assemble your product safely.
5. We recommend that, where possible, all items are assembled near to the area in which they will be placed in use, to avoid moving the product unnecessarily once assembled.
6. For the protection of your furniture, we recommend that the product is placed on a protected surface during assembly to prevent any damage.
7. During assembly please take care not to over-tighten any fittings, as this may damage the product. Do not use power tools.
8. Always place the product on a flat, steady and stable surface.
9. Do not stand on the product. Do not use the product as a stepladder.
10. This product is intended for indoor, household use only as it is a non-industrial product.
11. Please use caution and care when lifting the product to avoid personal injury and/or product damage.

ASSEMBLY REQUIREMENTS



- 1.5m x 1.5m assembly space required. Give your furniture some breathing room!
- Approximately 1 hour assembly time. Remember, it's not a race, so take your time, enjoy the process.
- 2 x adults required, enlist the help of your favourite tag team.

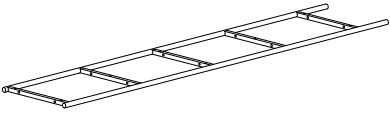

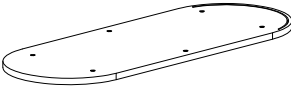
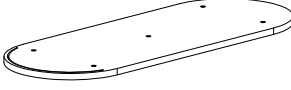
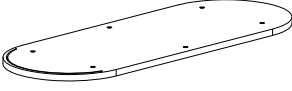
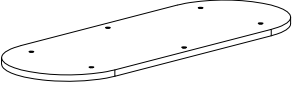
PARTS LIST

<p>1</p>  <p>X 2</p>	<p>2</p>  <p>X 8</p>	<p>3</p>  <p>X 4</p>	
<p>4</p>  <p>X 1</p>	<p>5</p>  <p>X 2</p>	<p>6</p>  <p>X 1</p>	<p>7</p>  <p>X 1</p>

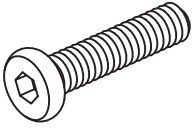
HARDWARE

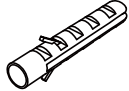
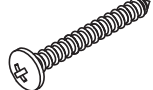
<p>A</p>  <p>D 6x25mm x 44</p>	<p>B</p>  <p>x 1</p>	<p>C</p>  <p>x 2</p>	<p>D</p>  <p>x 2</p>
<p>E</p>  <p>D 4x35mm x 2</p>			

ASSEMBLY INSTRUCTIONS

STEP 1

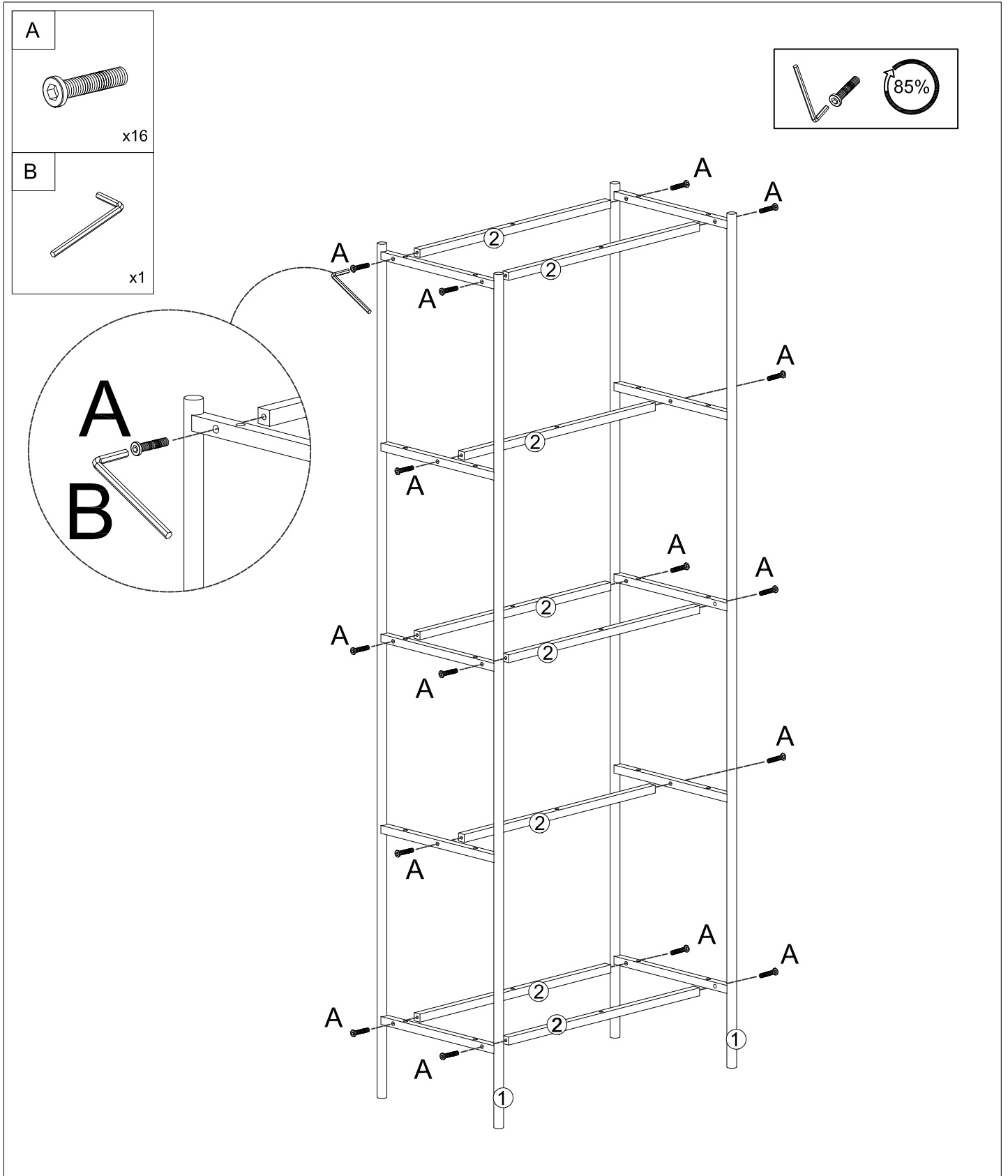

ASSEMBLY INSTRUCTIONS

STEP 2

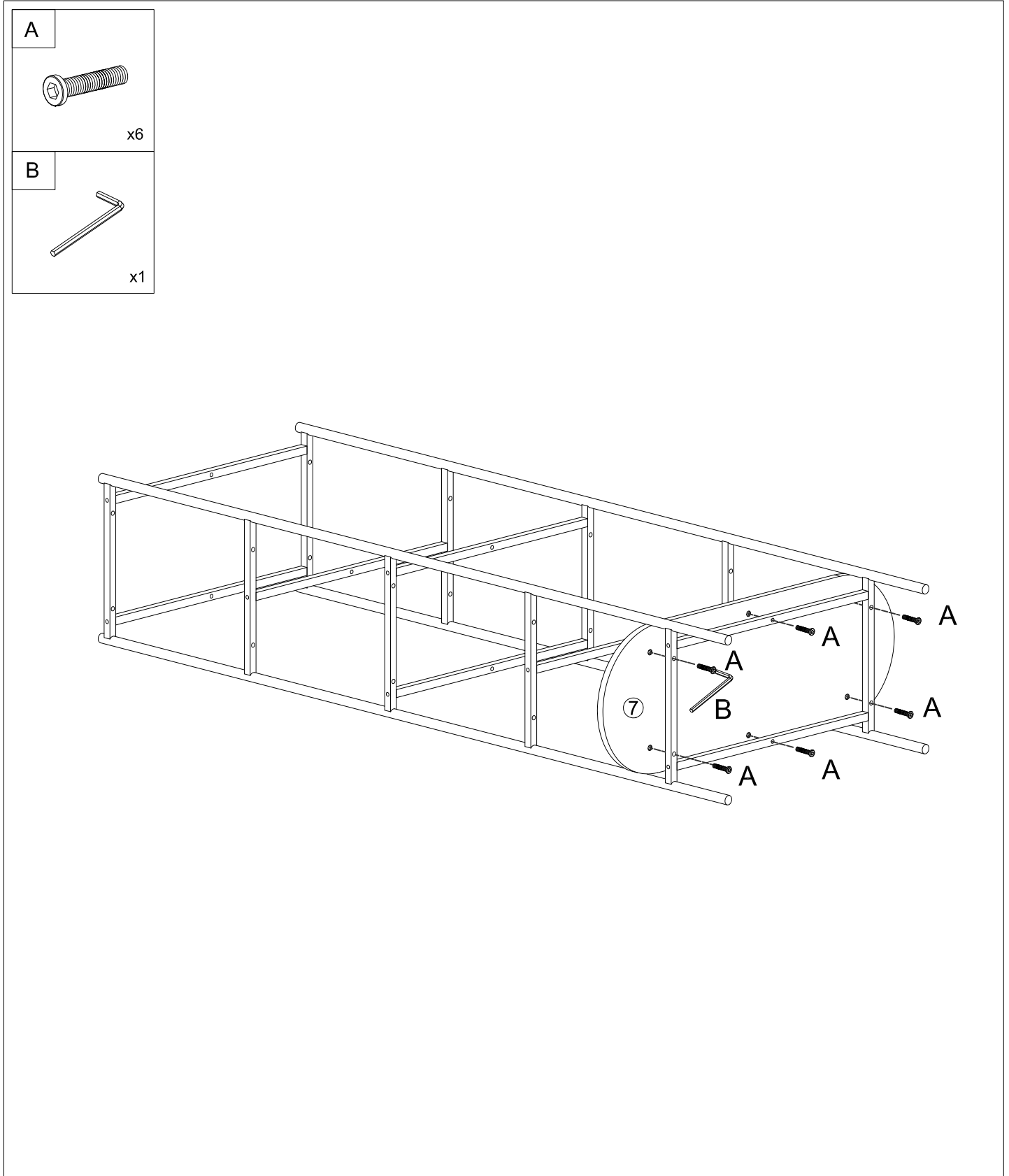

ASSEMBLY INSTRUCTIONS

STEP 3



ASSEMBLY INSTRUCTIONS

STEP 4

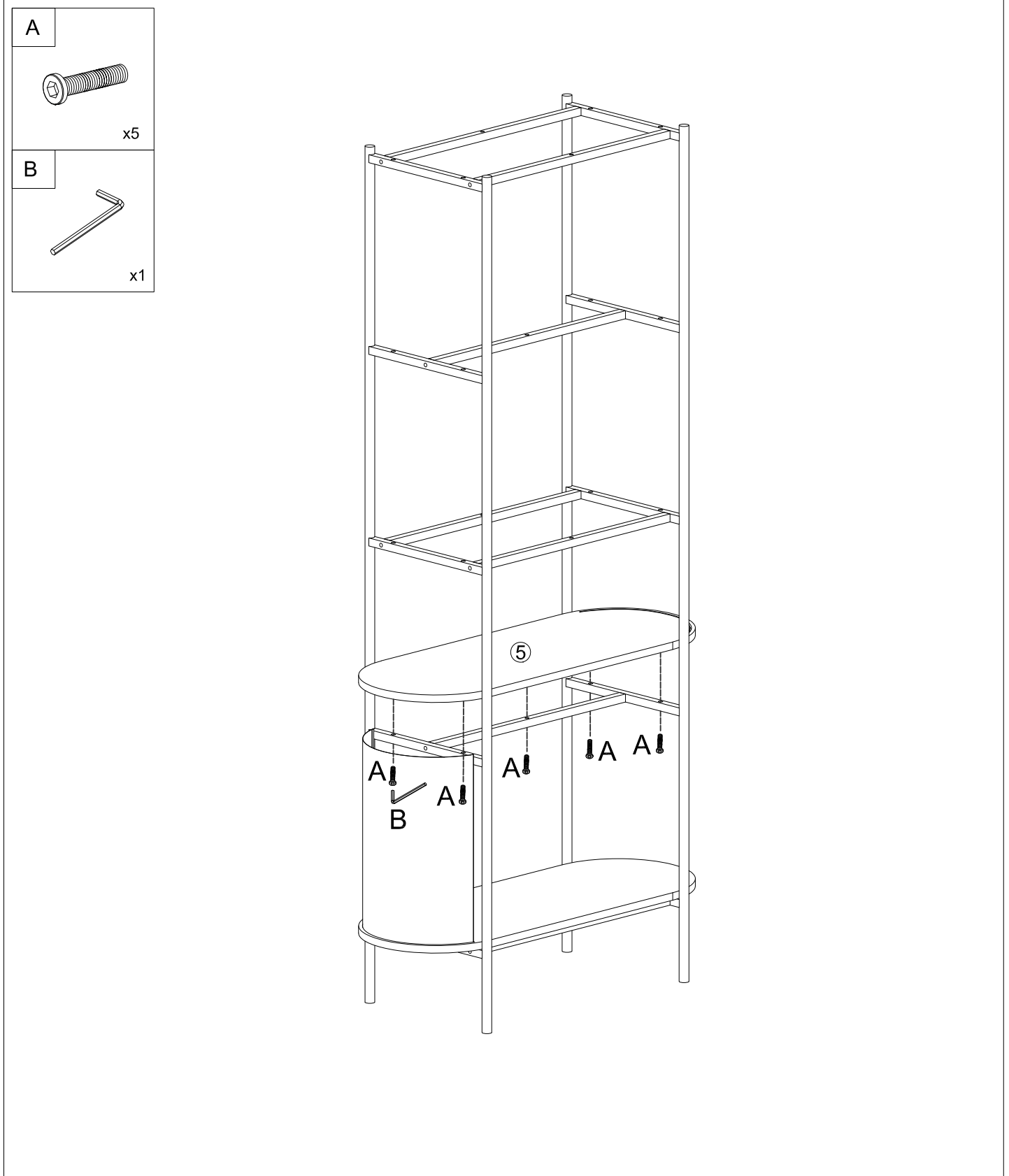

ASSEMBLY INSTRUCTIONS

STEP 5

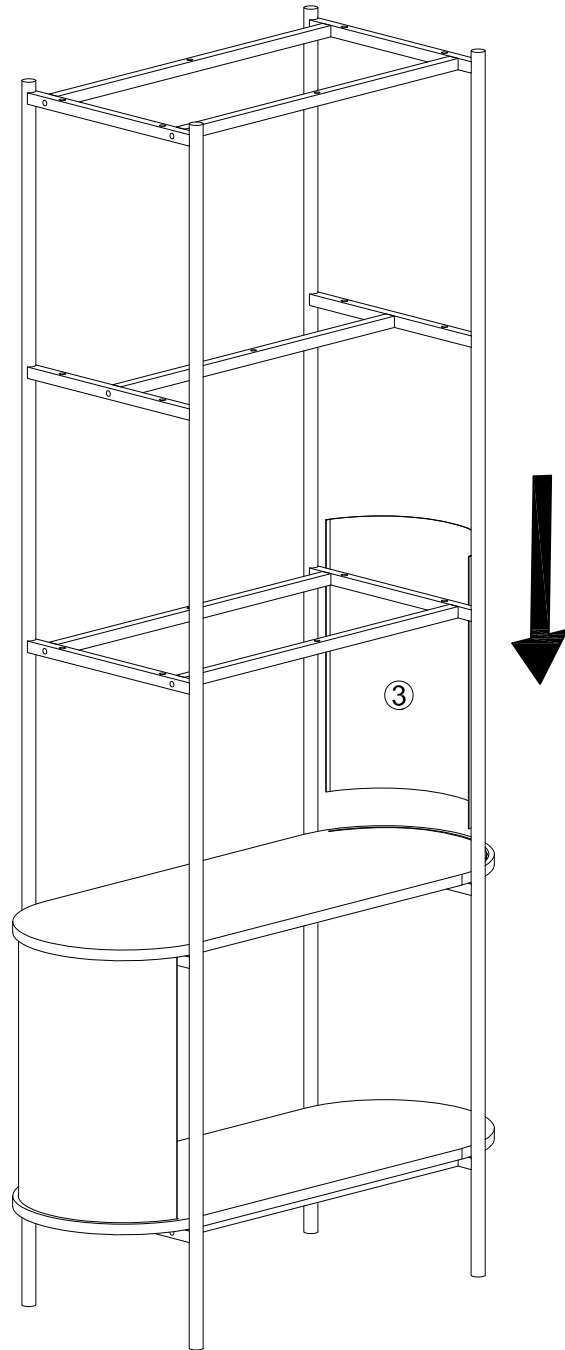

ASSEMBLY INSTRUCTIONS

STEP 6



ASSEMBLY INSTRUCTIONS

STEP 7



ASSEMBLY INSTRUCTIONS

STEP 8



ASSEMBLY INSTRUCTIONS

STEP 9

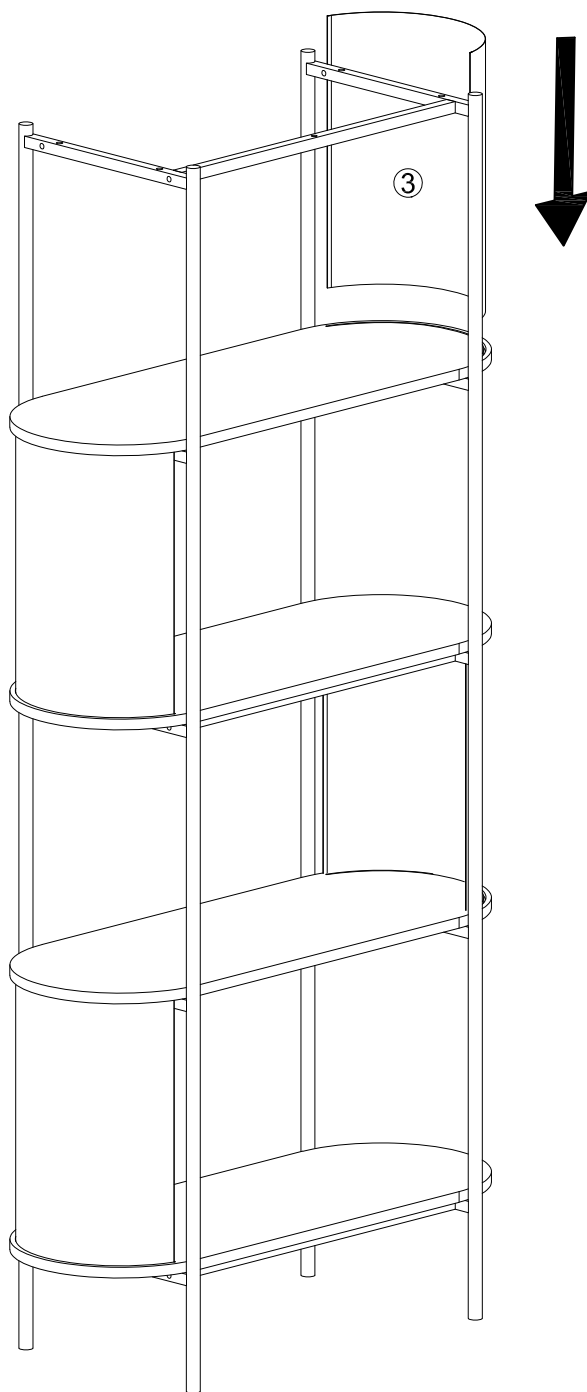

ASSEMBLY INSTRUCTIONS

STEP 10



ASSEMBLY INSTRUCTIONS

STEP 11

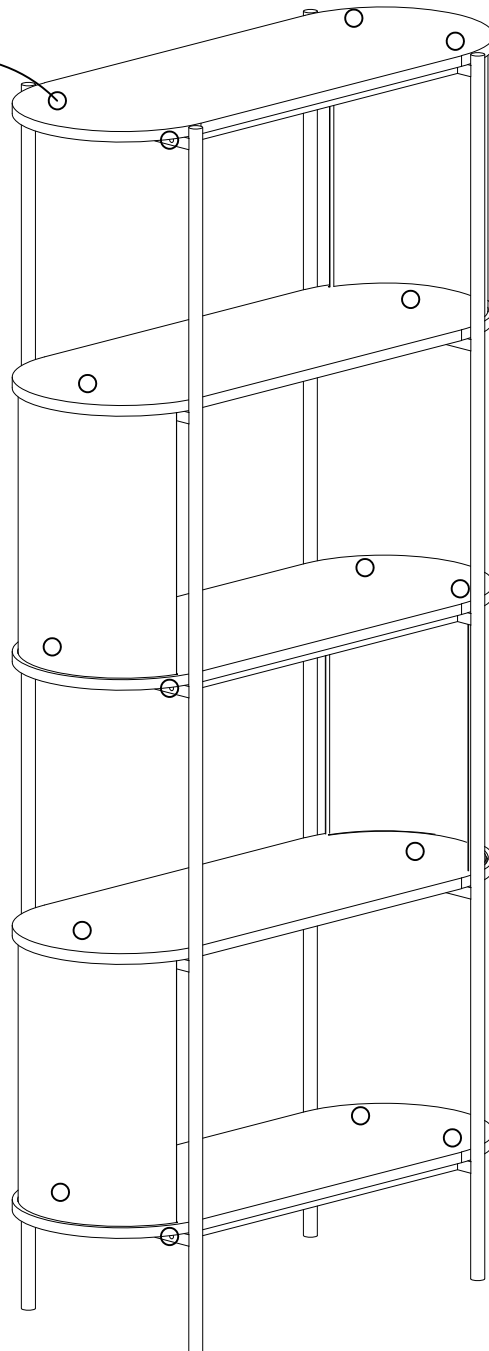
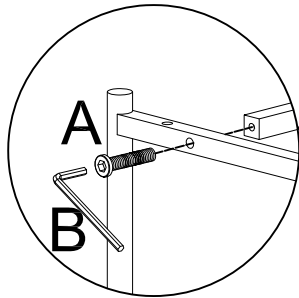
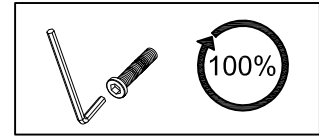
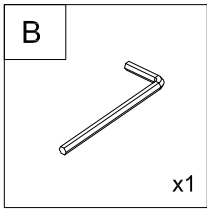

ASSEMBLY INSTRUCTIONS

STEP 12

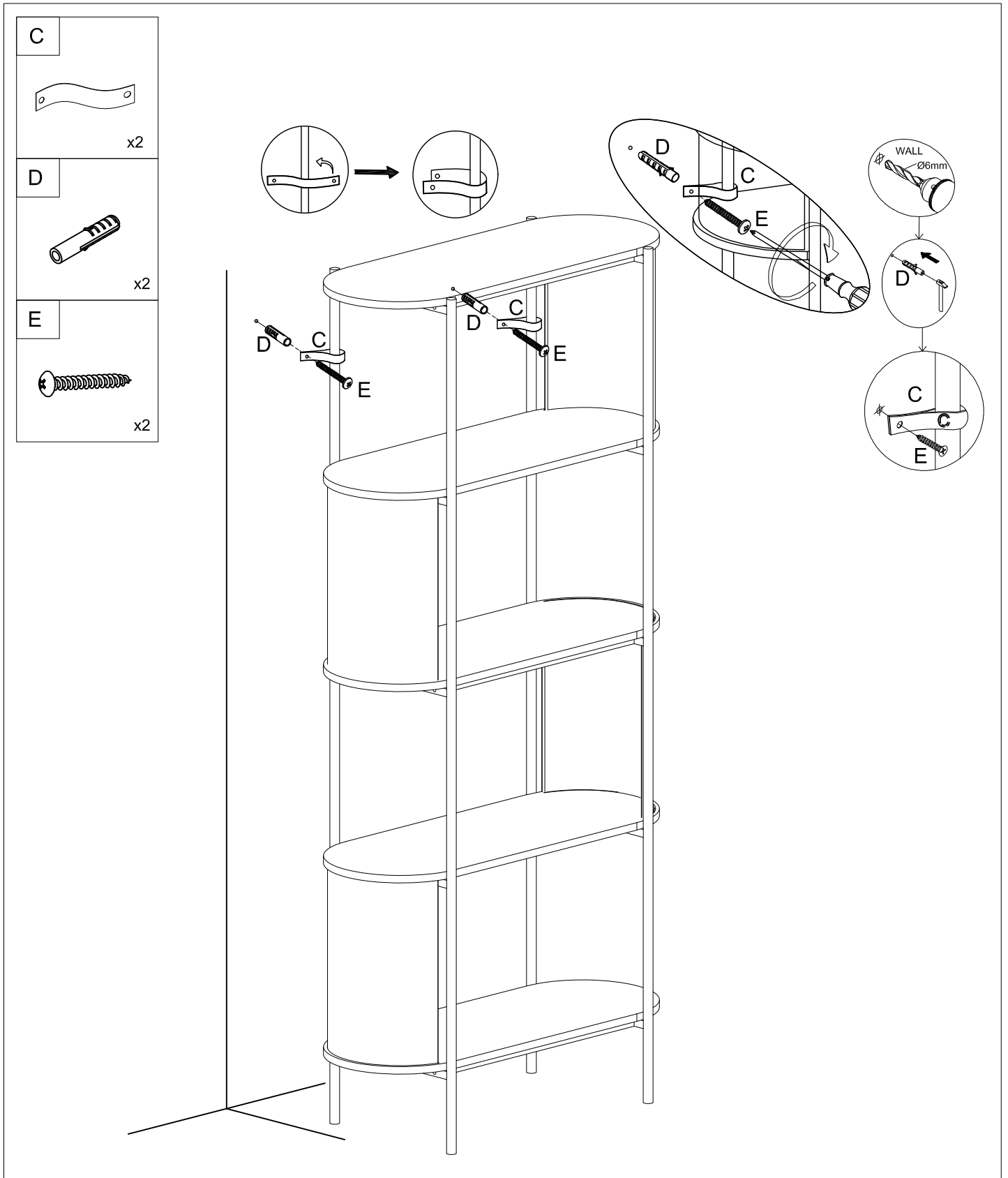

WARNING

WARNING

Children have died from furniture toppling over

- ALWAYS secure this furniture with an anchor device.
- NEVER allow children to stand, climb or hang on drawers, doors or shelves.
- NEVER open more than one drawer at a time.
- NEVER place televisions on this item.
- ALWAYS place heavy items low down

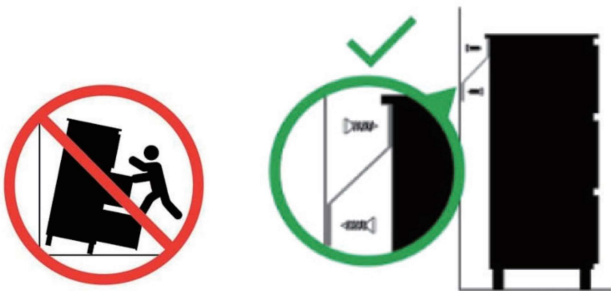

ASSEMBLY INSTRUCTIONS

RECOMMENDED WEIGHT

MAXIMUM RECOMMENDED WEIGHT IS 10KG FOR EACH SHELF.

Your new product is ready for use.

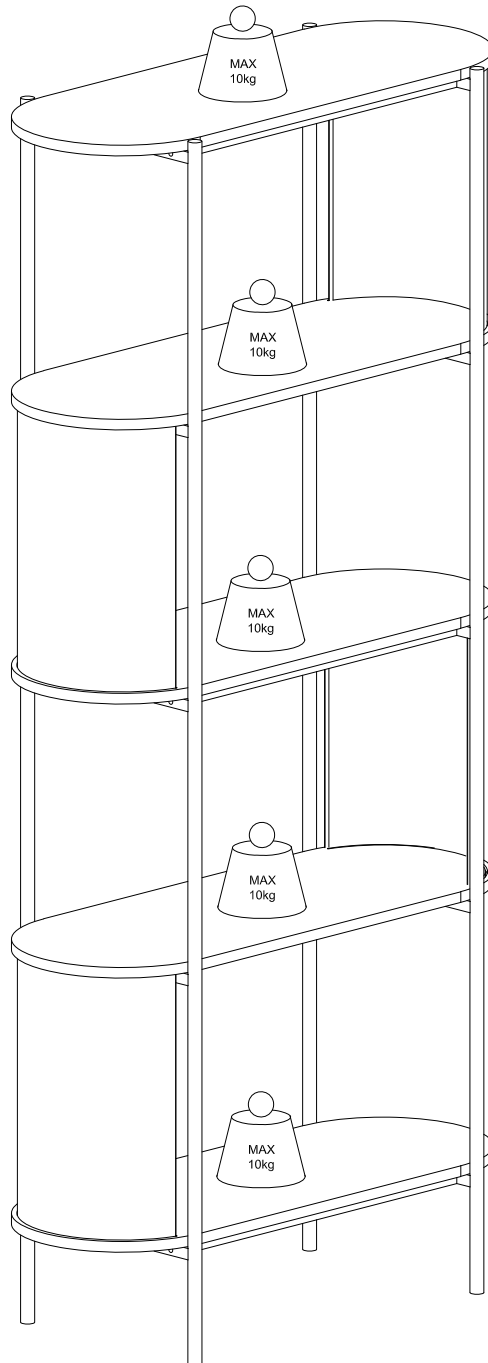

CARE & MAINTENANCE OF YOUR PRODUCT

Just a few simple steps to keep your furniture looking fabulous and functioning flawlessly:

- Please periodically check all fittings and re-tighten as necessary.
- To clean your item, please use a damp cloth and wipe clean.
- To clean glass, please use glass cleaner.
- Never allow any kind of liquid to remain on your furniture.
Absorption can cause wood to warp or finishes to de-laminate.
- Please do not place hot items (eg. hot drinks) directly on to the surface.
- Please do not drag and pull your furniture.

WARRANTY

Cooper & Co products are warranted to be free from defects in materials and workmanship for the warranty period of 12 months from the date of retail sale. Our goods come with guarantees that cannot be excluded under the Australian Consumer Law. You are entitled to a replacement or refund for a major failure and for compensation for any other reasonably foreseeable loss or damage. You are also entitled to have the goods repaired or replaced if the goods fail to be of acceptable quality and the failure does not amount to a major failure.

Cooper & Co.[®]

Cooper & Co products are waiting for you at:

www.cooperandco.com.au

Find us on Instagram at:

[cooperandco_australia](https://www.instagram.com/cooperandco_australia)